

Installation Guide

Insight Managed WiFi 6 AX6000 Tri-band Multi-Gig
Access Point
Model WAX630
Model WAX630PA

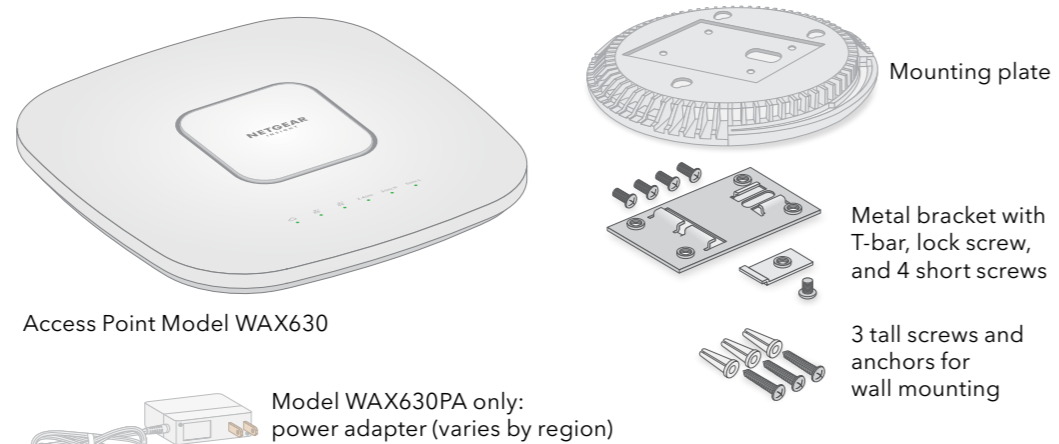

Package contents



Model WAX630PA only:
power adapter (varies by region)

NOTE: You can power up the WAX630 by connecting it to a PoE++ switch or power adapter. Model WAX630PA includes a power adapter, or you can purchase one separately.

Overview



CAUTION: Terms of Use
This device must be professionally installed. It is the installer's responsibility to follow local country regulations including operations within legal frequency channels, output power and DFS requirements. Vendor or Reseller or Distributor is not responsible for illegal wireless operations. Please see Device's Terms and Conditions for more details.

1. Connect to power and Internet

Power up the WAX630 access point (AP) by connecting the LAN 1/PoE++ port to a PoE++ switch that supplies 802.3bt power (60W PoE++ per-port), or to a power adapter.

Make sure that the AP has Internet connectivity:

- If you connect the AP to a switch, make sure that the switch has Internet connectivity.
- If you use a power adapter to provide power, use an Ethernet cable to connect the LAN 1/PoE++ port on the AP to a router or other network device on a network with Internet connectivity.

Sample connections for a NETGEAR Insight setup

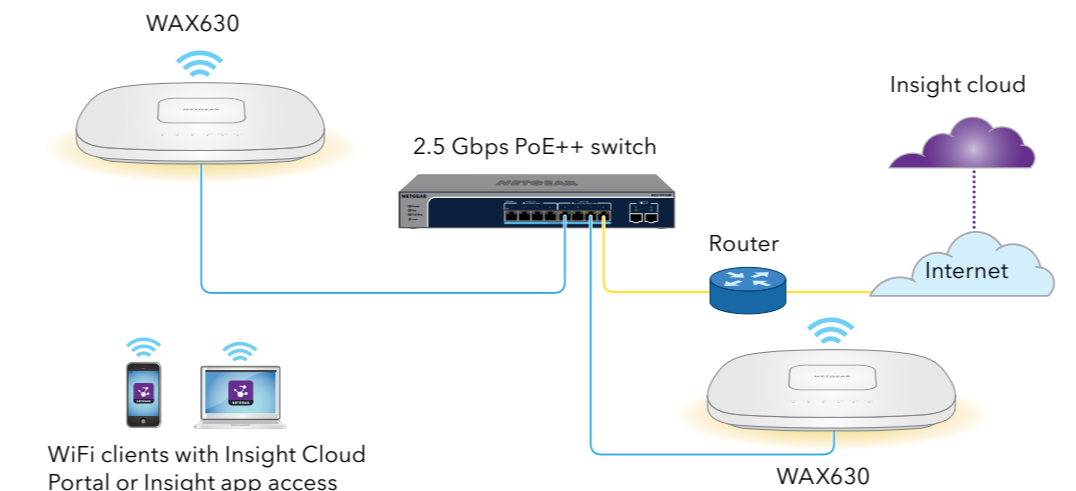

Sample connections for a standalone setup

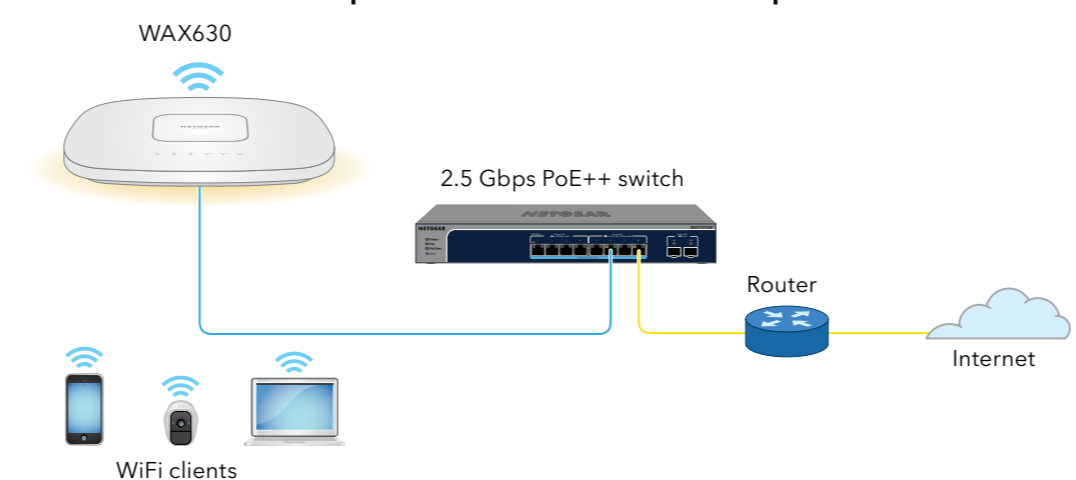

If connected to 2.5 Gbps equipment, the WAX630 LAN 1/PoE++ port supports Ethernet speeds up to 2.5 Gbps within your LAN. The preceding figures show a NETGEAR MS510TXUP switch, which supports speeds of 2.5 Gbps and higher, as well as PoE++. If your Internet connection, modem, router, and switch support a speed of 2.5 Gbps, the AP's Internet connection also functions at 2.5 Gbps. Otherwise, the Internet connection functions at 1 Gbps, which is a common speed.

NOTE: The AP receives an IP address from a DHCP server (or a router that functions as a DHCP server) in your network. If your network does not include a DHCP server, the AP uses its default IP address: 192.168.0.100.

After starting up and during setup, the AP's LEDs can light in these colors:

Power/Cloud		Slow blinking amber. The AP is starting, the firmware is being upgraded, or the AP is trying to get an IP address.
		Solid green. The AP started up and functions either as a standalone AP, or as an Insight discovered AP that is not currently connected to the Insight cloud.
		Solid blue. The AP functions in Insight mode and is connected to the Insight cloud.
LAN 1 (one of two speed options)		Solid or blinking green. The LAN 1 port detects a speed of 2.5 Gbps.
		Solid or blinking amber. The LAN 1 port detects a speed of less than 2.5 Gbps, such as 1 Gbps (which is a common speed).
LAN 2 (one of two speed options)		Solid or blinking green. The LAN 2 port detects a speed of 1 Gbps.
		Solid or blinking amber. The LAN 2 port detects a speed of 100 or 10 Mbps.
2.4 GHz WLAN 5 GHz H WLAN 5 GHz L WLAN		Solid green: The radio is operating without clients.
		Solid blue: The radio has at least one connected client.
		Blinking blue: The radio is processing traffic.

For more information about the LEDs, see the user manual, which you can download by visiting netgear.com/support/download.

2. Configure and manage the AP

Insight remote management offers additional features and add-on services that are not available in standalone mode. Your new Insight-manageable device comes with Insight included. For more information, visit the following pages:

- netgear.com/business/services/insight/subscription/
- kb.netgear.com/000061848

To configure and manage the AP, use one of the methods in this table:

A.	Cloud Portal/remote method	NETGEAR Insight Cloud Portal See A. Use the NETGEAR Insight Cloud Portal to configure the AP
B.	Insight app/remote method	NETGEAR Insight app See B. Use the NETGEAR Insight app to configure the AP
C.	Standalone/local method	Web browser See C. Configure the AP as standalone in a web browser

If you want to use Insight remote management, your NETGEAR account is also your Insight account. Your NETGEAR account credentials let you log in as an Insight Premium user, or if you upgrade to an Insight Pro account, as an Insight Pro user.

If you do not already have an Insight account, you can create an account now. For information about creating an Insight Premium account or upgrading to an Insight Pro account, visit kb.netgear.com/000044343.

A. Use the NETGEAR Insight Cloud Portal to configure the AP

- Make sure that the AP is connected to the Internet.
 - On a computer or tablet, visit insight.netgear.com/.
 - Enter the email address and password for your NETGEAR account and click the **NETGEAR Sign In** button.
 - Only if you are an Insight Pro user, select the organization to which you want to add the AP.
 - Add a new network location where you want to add the AP, or select an existing network location.
 - Click the **+** (**Add Device**) button.
- NOTE:** If you are an Insight Pro user, you can either add a single device or you can add multiple Insight managed devices by uploading a device list as a CSV file.
- In the Add New Device pop-up page, enter the AP's serial number and MAC address, and then click **Go**.
 - After Insight verifies that the AP is a valid product, you can optionally change the device name of the AP, and then click **Next**.

When the AP is successfully added to the portal, a page displays a confirmation that setup is in progress.

NOTE: If the AP is online but Insight does not detect the AP, the firewall at the physical location where the AP is located might prevent communication with the Insight cloud. In that situation, add port and DNS entries for outbound access to the firewall. For more information, see kb.netgear.com/000062467.

The AP automatically updates to the latest Insight firmware and Insight location configuration. This might take up to 10 minutes, during which time the AP will restart.

The AP is now an Insight managed device that is connected to the Insight cloud-based management platform. If the Power/Cloud LED was solid green, it lights solid blue.

You can use the Insight Cloud Portal or Insight app to configure and manage the AP.

B. Use the NETGEAR Insight app to configure the AP

- Connect your mobile device to the AP's setup SSID (WiFi network name) using one of these methods:
 - Scan the QR code:** Scan the QR code on the AP label to connect to the setup SSID.
 - Connect manually:** The setup SSID is on the AP label and is shown in the format NETGEARxxxxx-SETUP, where xxxxxx are the last six digits of the AP's MAC address. The default WiFi passphrase is **sharedsecret**.
- Open the NETGEAR Insight app.
- Enter the email address and password for your account and tap **LOG IN**.
- Add a new network location where you want to add the AP by tapping the **Next button**, and then tapping **OK**. You can also select an existing network location.

The device admin password that you entered for the new network location replaces the existing admin password on all devices that you add to the network location.

In most situations, Insight detects the AP automatically, which can take several minutes.

- To add the AP to your network location, do one of the following:
 - If the AP is automatically detected and listed in the Insight Manageable Devices section, tap the icon for the AP, and then tap the **ADD DEVICE** button.
 - If the AP is not automatically detected, or you prefer to use another method to add the AP, tap the **+** icon in the top bar, and do one of the following:
 - Tap the **SCAN BARCODE OR QR CODE** button, and then scan the AP's code.
 - Tap the **Enter Serial Number and MAC Address** link, and then manually enter the AP's serial number and MAC address.

Continued on the next page.



NETGEAR, Inc. July 2022
350 East Plumeria Drive
San Jose, CA 95134, USA

NETGEAR INTERNATIONAL LTD
Floor 1, Building 3,
University Technology Centre
Curraheen Road, Cork,
T12EF21, Ireland

© NETGEAR, Inc., NETGEAR and the NETGEAR Logo are trademarks of NETGEAR, Inc. Any non-NETGEAR trademarks are used for reference purposes only.

- If prompted, name the AP and tap the **Next** button.
The AP automatically updates to the latest Insight firmware and Insight location configuration. This might take up to 10 minutes, during which time the AP will restart.
The AP is now an Insight-managed device that is connected to the Insight cloud-based management platform. If the Power/Cloud LED was solid green, it lights solid blue.
You can use the Insight app or Insight Cloud Portal to configure and manage the AP.

C. Configure the AP as standalone in a web browser

- Connect your computer or mobile device to the AP's setup SSID (WiFi network name) using one of the following methods:
 - Scan the QR code:** Scan the QR code on the AP label to connect to the setup SSID.
 - Connect manually:** The setup SSID is on the AP label and is shown in the format NETGEARxxxxxx-SETUP, where xxxxxx are the last six digits of the AP's MAC address. The default WiFi passphrase is **sharedsecret**.
- On your computer, launch a web browser and, in the address bar, enter **aplogin.net**.
Your browser might display a security warning because of the self-signed certificate on the AP, which is expected behavior. You can proceed, or add an exception for the security warning. For more information, see kb.netgear.com/000062980/.
- Enter the AP user name and default password. The user name is **admin**. The default password is **password**. The user name and password are case-sensitive.
- Select the **Web-browser (Local)** radio button.
The Day Zero Easy Setup page displays.
- Follow the instructions on the Day Zero Easy Setup page, and then click the **Apply** button.
We recommend that you make a note of the new admin password, SSID (WiFi network name), WiFi passphrase, and IP address to keep in a safe place.
A message displays to indicate that your settings are being applied.
- If the WiFi connection of your computer or mobile is terminated, reconnect to the AP using the new SSID and WiFi passphrase that you set on the Day Zero Easy Setup page.
- When the login page displays, you can log in to the AP using your new admin password to configure the AP.
For information about configuring the AP, see the user manual, which you can download by visiting netgear.com/support/download/.
We recommend that you register your AP with Netgear.
- To register your AP with NETGEAR:
 - From a computer or mobile device that is connected to the Internet, visit my.netgear.com.
 - Log in to your NETGEAR account.
If you do not already have a NETGEAR account, you can create an account now.
The My Products page displays.
 - From the menu on the left, select **Register a Product**.
 - In the Serial Number field, type the serial number of your AP.
The serial number is 13 digits long. It is printed on the AP label.
 - From the Date of Purchase menu, select the date that you purchased the AP.
 - Click the **REGISTER** button.
Your AP is registered to your NETGEAR account.
A confirmation email is sent to your NETGEAR account email address.

Mounting options

You can mount the AP to a wall or to a ceiling with a 15/16 in. (24 mm) T-bar, or you can install the AP freestanding on a flat surface.

We recommend that you use a flat Ethernet cable so that the cable fits in the narrow space between the AP and the surface on which it is mounted or placed.

Before you mount the AP, first set up and test the AP to verify WiFi network connectivity.

Mount the AP on a wall

CAUTION: Make sure that the wall is not damaged.
For example, water damage can destroy a drywall.

- Place the mounting plate on the wall.
- Mark the wall where the mounting holes are.
- Using a 3/16 in. (4.7 mm) drill bit, drill holes in the wall.
- Tap each anchor into the wall with a soft mallet until the anchors are flush with the wall.
- Use the screws to attach the mounting plate to the wall.

NOTE: Do not insert the screws into the wall without anchors.

- Connect any cables.
- Attach the AP to the mounting plate.

- Twist the AP clockwise to lock it onto the mounting plate.

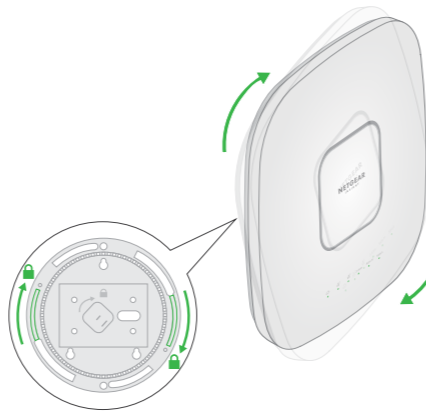
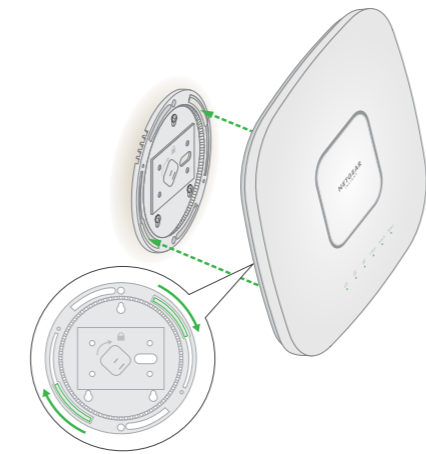
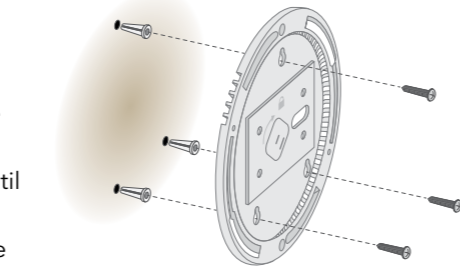

Mount the AP to a T-bar

- Slide the T-bar partially into the metal bracket.
- Attach the metal bracket to the ceiling bar.
- Push the T-bar over the ceiling bar.
- Use the lock screw to lock the metal bracket into place.

- Use the four short screws to attach the mounting plate to the T-bar.
- Connect a PoE cable or power adapter to the AP before mounting.
The AP is designed to be unobtrusive, so it sits flat on the ceiling surface when it is mounted.

- Hold the AP upside down and attach it to the mounting plate.

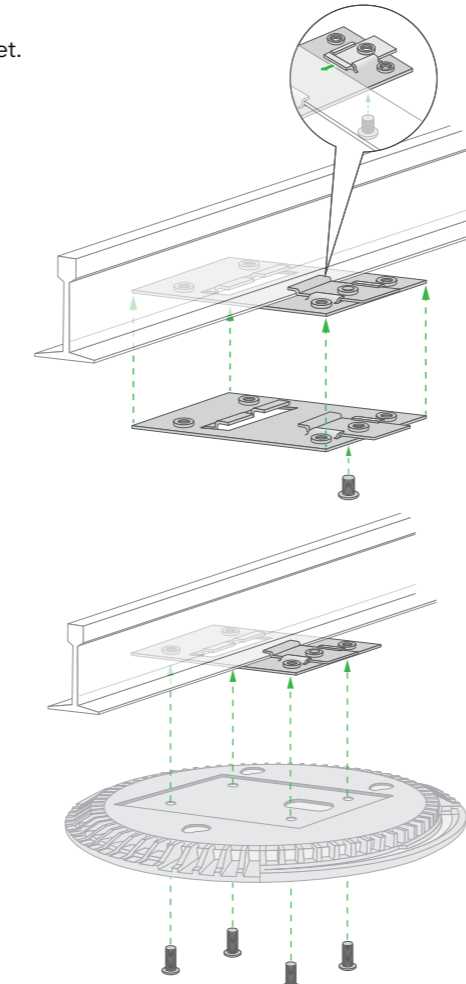
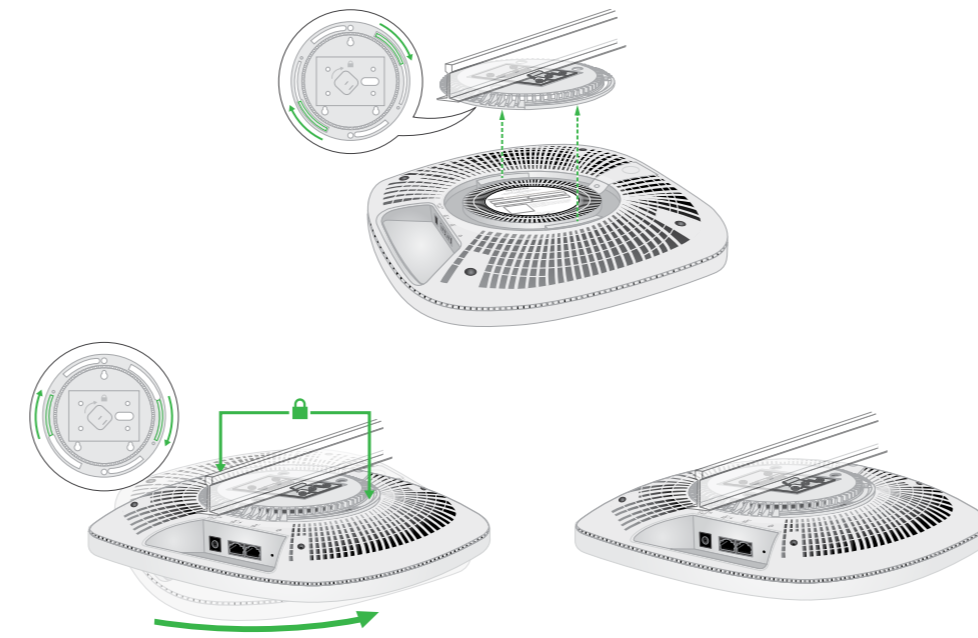

- Twist the AP clockwise to lock it onto the mounting plate.

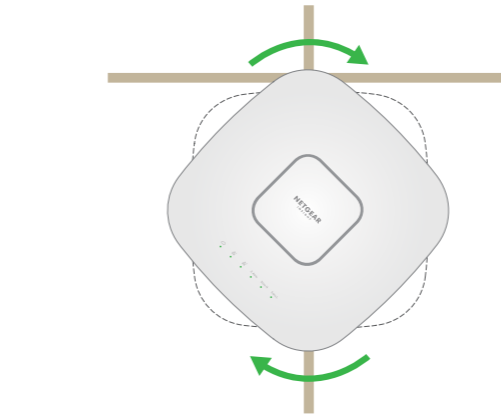

Unmount the AP

CAUTION: Make sure you hold the AP so that it does not drop when you release it from the mounting plate.

- To find the locking latch, place your thumb on the center of the LEDs, and your finger on the other side of the device, directly opposite the thumb.
- Press and hold the latch down to release the lock and keep the lock open.

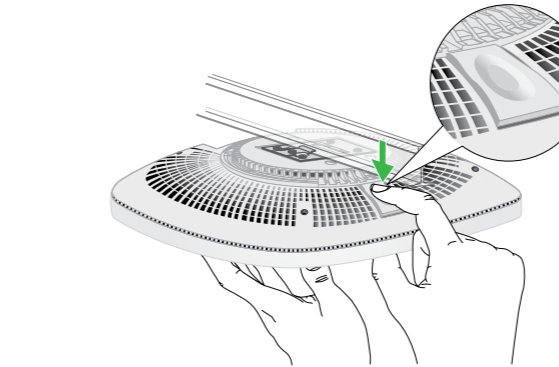

- Turn the AP counterclockwise until the AP releases from the mounting plate.
The mounting plate remains attached to the T-bar or the wall.

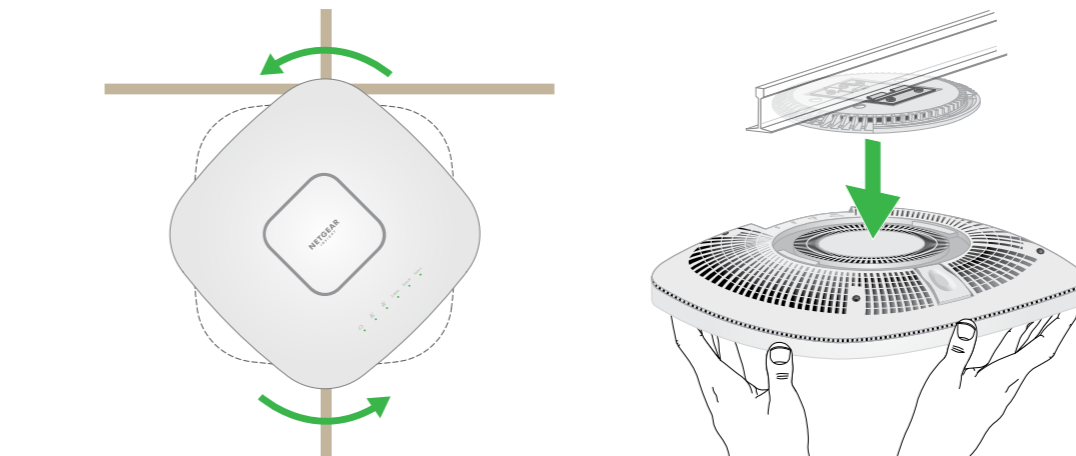

Support and Community

Visit netgear.com/support to get your questions answered and access the latest downloads.
You can also check out our NETGEAR Community for helpful advice at community.netgear.com.

Regulatory and Legal

Si ce produit est vendu au Canada, vous pouvez accéder à ce document en français canadien à <https://www.netgear.com/support/download/>.

(If this product is sold in Canada, you can access this document in Canadian French at <https://www.netgear.com/support/download/>.)

For regulatory compliance information including the EU Declaration of Conformity, visit <https://www.netgear.com/about/regulatory/>.

See the regulatory compliance document before connecting the power supply.

For NETGEAR's Privacy Policy, visit <https://www.netgear.com/about/privacy-policy>.

By using this device, you are agreeing to NETGEAR's Terms and Conditions at <https://www.netgear.com/about/terms-and-conditions>. If you do not agree, return the device to your place of purchase within your return period.

Do not use this device outdoors. The PoE source is intended for intra building connection only.

For 6 GHz devices: Only use this device indoors. The operation of 6 GHz devices is prohibited on oil platforms, cars, trains, boats, and aircraft, except that operation of this device is permitted in large aircraft while flying above 10,000 feet. Operation of transmitters in the 5.925-7.125 GHz band is prohibited for control of or communications with unmanned aircraft systems.